



ADX2FD

Handheld Transmitter

User guide for the Shure ADX2FD Frequency Diversity handheld transmitter
Version: 11.0 (2020-K)

Table of Contents

ADX2FD Handheld Transmitter	3	Menu Parameter Descriptions	10
WARNING	3	Radio Menu	10
ADX2FD Handheld Transmitter	3	Audio Menu	11
Features	3	Utilities Menu	11
Performance	3	IR Sync	12
Design	4	Setting the Frequency Manually	13
Power	4	RF Mute	13
Included Components	4	Safe Start	14
Choice of (1) of the following Shure microphone cartridges:	4	Operating in Frequency Diversity Mode	14
Optional Accessories	4	Turning Off Frequency 2 (Freq 2)	15
Optional Shure microphone cartridges:	5	Input Overload	15
ADX2FD Transmitter Overview	5	Tone Generator	15
Transmitter Controls	6	Matching Audio Levels with Mic Offset	15
Home Screen Display	7	ShowLink Test	16
Locking the Interface	7	Updating Firmware	16
Shure Rechargeable Batteries	7	Firmware Versioning	16
Checking Battery Info	8	Updating the Transmitter	17
Important Tips for Care and Storage of Shure Rechargeable Batteries	8	Specifications	17
Battery Installation	9	Frequency Range and Transmitter Output Power	18
ADX2FD SB920 Battery Runtime	9	Australia Warning for Wireless	21
Installing the Battery Contact Cover	9	LICENSING INFORMATION	21
Menu Parameters	9	Certifications	21
Tips for Editing Menu Parameters	10	Information to the user	22
Menu Map	10	Contact Customer Support	23

ADX2FD Handheld Transmitter

WARNING

- Battery packs may explode or release toxic materials. Risk of fire or burns. Do not open, crush, modify, disassemble, heat above 140°F (60°C), or incinerate.
- Follow instructions from manufacturer
- Only use Shure charger to recharge Shure rechargeable batteries
- **WARNING:** Danger of explosion if battery incorrectly replaced. Replace only with same or equivalent type.
- Never put batteries in mouth. If swallowed, contact your physician or local poison control center
- Do not short circuit; may cause burns or catch fire
- Do not charge or use battery packs other than Shure rechargeable batteries
- Dispose of battery packs properly. Check with local vendor for proper disposal of used battery packs.
- Batteries (battery pack or batteries installed) shall not be exposed to excessive heat such as sunshine, fire or the like
- Do not immerse the battery in liquid such as water, beverages, or other fluids.
- Do not attach or insert battery with polarity reversed.
- Keep away from small children.
- Do not use abnormal batteries.
- Pack the battery securely for transport.

Note: Use only with the included power supply or a Shure-approved equivalent.

ADX2FD Handheld Transmitter

ADX series transmitters deliver impeccable audio quality and RF performance, and are equipped with ShowLink® remote control for real-time parameter adjustments and interference avoidance. This transmitter additionally features Frequency Diversity for seamless audio in even the most challenging environments. Light-weight aluminum construction, SB920 rechargeable power options (with dockable charging).

Features

Performance

- 184 MHz tuning range
- Frequency Diversity enables simultaneous transmission on two independent frequencies to ensure seamless, uninterrupted audio for mission-critical applications. Single carrier mode is available if Frequency Diversity is not required.
- 20 Hz to 20 kHz range with flat frequency response
- Automatic input staging optimizes gain setting
- Diversity ShowLink-enabled for remote transmitter control and automatic interference avoidance
- AES 256-bit encryption-enabled for secure transmission
- >120 dB, A-weighted, System Gain @ +10
- Digital output: >125dB, A-weighted (Dante, AES3, AES67)

- 100 meter (300 feet) line-of-sight operating range
- Selectable modulation modes optimize performance for spectral efficiency or audio quality:
 - Standard – optimal coverage, low latency
 - High density – dramatic increase in max system channel count
- Switchable Power Levels (region dependent):
 - 2/10/50 mW (single carrier mode)
 - 2 x 20 mW (Frequency Diversity mode)
- Built-in tone generator and RF markers to facilitate range-testing

Design

- Interchangeable Shure microphone cartridges
- Backlit LCD with easy to navigate menu and controls
- Rugged metal construction
- Menu and power lockout

Power

- Shure SB920 rechargeable batteries offer precision metering and zero memory effect
- External charging contacts for docked charging
- Battery Runtime with Shure SB920:
 - Up to 9 hours in single carrier mode @ 10 mW
 - Up to 6.5 hours in Frequency Diversity mode @ 10 mW x 10 mW
 - Up to 5 hours in single carrier, high-power mode @ 50 mW

Included Components

SB920 Shure Rechargeable Battery	95A25763
Zipper Bag	95B2313
Threaded Adapter	31B1856
Swivel Adapter, black	90F4046

Choice of (1) of the following Shure microphone cartridges:

SM58 (RPW112)	KSM9 Nickel (RPW188)
BETA 87C (RPW122)	BETA 87A (RPW120)
BETA 58A (RPW 118)	KSM9 Black (RPW184)
KSM8 Black (RPW174)	KSM8 Nickel (RPW170)
KSM9HS Black (RPW186)	KSM9HS Nickel (RPW190)

Optional Accessories

SB920 Shure Rechargeable Battery	95A25763
Battery Contact Cover (part number varies by frequency range)	WA619-A (470-636 MHz), WA619-B (606-810 MHz), WA619-C (750-960 MHz)
AD651B Talk Switch Button (black)	90A37347B
Microphone stand adapter	WA371
Shure Networked Docking Charger 2-Up	SBC240

Optional Shure microphone cartridges:

SM58 (RPW112)
SM86 (RPW114)
SM87A (RPW116)
BETA 58A (RPW118)
BETA 87A (RPW120)
BETA 87C (RPW122)
VP68 (RPW124)
KSM9 Nickel (RPW188)
KSM9HS Nickel (RPW190)
KSM9 Black (RPW184)
KSM9HS Black (RPW186)

ADX2FD Transmitter Overview

① Microphone Cartridge

See Optional Accessories for a list of compatible cartridges.

② Display

View menu screens and settings. Press any control button to activate the backlight.

③ Infrared (IR) Port

Align with the receiver IR port during an IR Sync for automated transmitter programming.

④ Control Buttons

Use to navigate through parameter menus and change values.

⑤ Battery Compartment

Requires Shure rechargeable battery.

⑥ On/Off Switch

Powers the unit on or off.

⑦ Handle

Unscrew to access controls and batteries.

⑧ Battery Charging Contacts

Charging contacts for use with docking battery chargers.

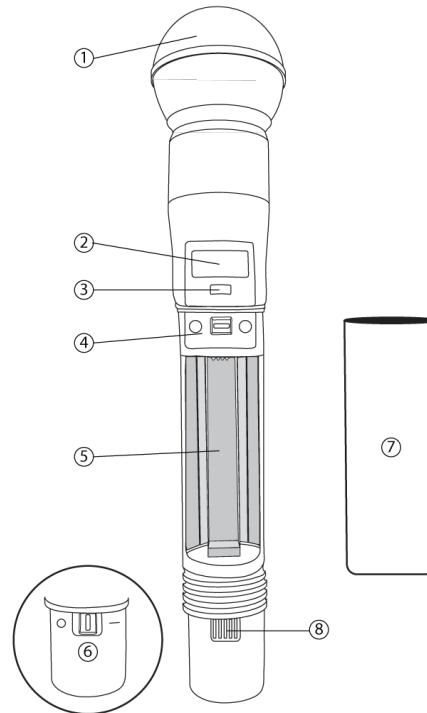

Transmitter Controls

Use to navigate through parameter menus and change values.

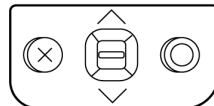

X	Acts as a 'back' button to return to previous menus or parameters without confirming a value change
O	Enters menu screens and confirms parameter changes
VA	Use to scroll through menu screens and to change parameter values

Tip: Use the following shortcuts for quick setup:

- Hold the \wedge button while powering on to lock or unlock the transmitter controls.
- Hold the X button while powering on to enter the Safe Start menu.





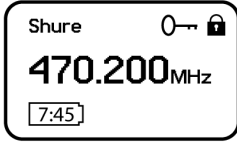

Home Screen Display

The home screen shows transmitter information and status.

There are four pieces of information that you can choose to see on the home screen. Use the arrow buttons to select one of the following choices:

<p>Name F1 and F2 Frequency Settings F1 and F2 Group (G) and Channel (C) Device ID</p>	
---	--

The following icons indicate transmitter settings:

	Battery runtime in hours and minutes or bar display
	Key: Displayed when encryption is enabled
	Displayed when controls are locked. Icon will flash if access is attempted to a locked control (power or menu).
	ShowLink signal strength displays 0 to 5 bars
	STD: Standard Transmission Mode
	HD: High Density Transmission Mode
	RF Mute Engaged: Displayed when RF output is muted

Locking the Interface

Lock transmitter interface controls to prevent accidental or unauthorized changes to parameters. The lock icon appears on the home screen when the interface lock is enabled.

1. From the Utilities menu, navigate to Locks and select one of the following lock options:
 - None: The controls are unlocked
 - Power: The power switch is locked
 - Menu: The menu parameters are locked
 - All: The power switch and menu parameters are locked
2. Press O to save.

To quickly unlock a transmitter: Press O twice, select None, and press O.

Shure Rechargeable Batteries

Shure lithium-ion batteries offer a rechargeable option for powering the transmitters. Batteries quickly charge to 50% capacity in one hour and reach full charge within three hours.

Single chargers and multiple bay chargers are available to recharge the Shure batteries.

Caution: Only charge Shure rechargeable batteries with a Shure battery charger.

Checking Battery Info

When using a Shure rechargeable battery, the receiver and transmitter home screens display the number of hours and minutes remaining.

Detailed information for the battery is displayed Battery menu of the transmitter: **Utilities > Battery**

- **Battery:** The chemistry type of for the installed battery (Shure, Alkaline, Lithium, NiMH)
- **Bars:** Indicates the number of bars displayed
- **Time:** Battery runtime
- **Charge:** Percentage of charge capacity
- **Health:** Percentage of current battery health
- **Cycle Count:** Total of the number of charging cycles for the installed battery
- **Temperature:** Battery temperature reported in Celsius and Fahrenheit

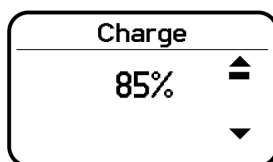

Important Tips for Care and Storage of Shure Rechargeable Batteries

Proper care and storage of Shure batteries results in reliable performance and ensures a long lifetime.

- Always store batteries and transmitters at room temperature
- Ideally, batteries should be charged to approximately 40% of capacity for long-term storage
- Periodically clean the battery contacts with alcohol to maintain ideal contact
- During storage, check batteries every 6 months and recharge to 40% of capacity as needed

For additional rechargeable battery information, visit www.shure.com.

Battery Installation

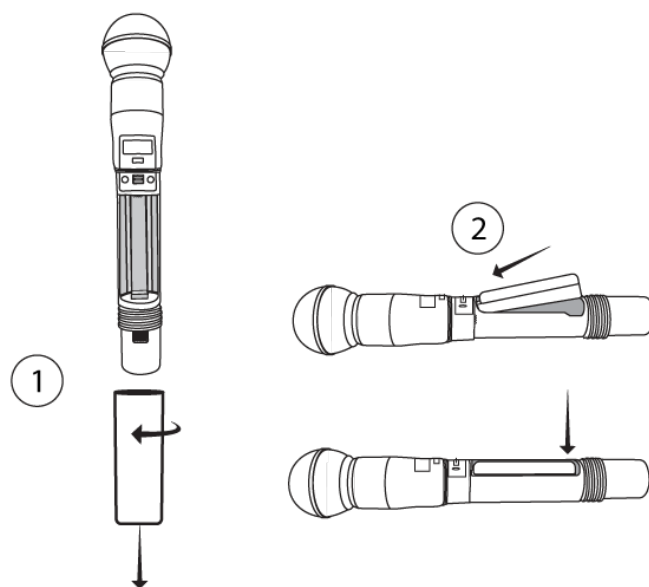

① Accessing the Battery Compartment

Unscrew and remove the handle as shown.

② Inserting the Battery

Insert the battery, contacts first into the battery compartment. Press down on the tab to fully seat the battery, and then reinstall the handle.

Tip: To remove the battery, pull up on the tab on the bottom of the battery.

ADX2FD SB920 Battery Runtime

Note: Higher RF power levels decrease battery runtime. Battery runtime varies with battery age and environmental conditions.

Signal Carrier Mode			Frequency Diversity Mode		
2 mW	10 mW	50 mW	2 mW x 2 mW	10 mW x 10 mW	20 mW x 20 mW
8.5 to 10.5 hours	7.5 to 9.5 hours	5.0 to 7.0 hours	5.5 to 7.5 hours	5.0 to 7.0 hours	4.5 to 6.5 hours

Installing the Battery Contact Cover

Use battery contact covers to prevent reflections from the battery contacts during broadcasts or live performances.

Menu Parameters

The Main menu organizes the available transmitter parameters into three categories:

- Radio
- Audio
- Utilities

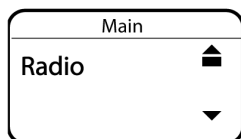

Tips for Editing Menu Parameters

- To access the menu options from the home screen, press O . Use the arrow buttons to access additional menus and parameters.
- A menu parameter will blink when editing is enabled
- To increase, decrease or change a parameter, use the arrow buttons
- To save a menu change, press O
- To exit a menu without saving a change, press X

Menu Map

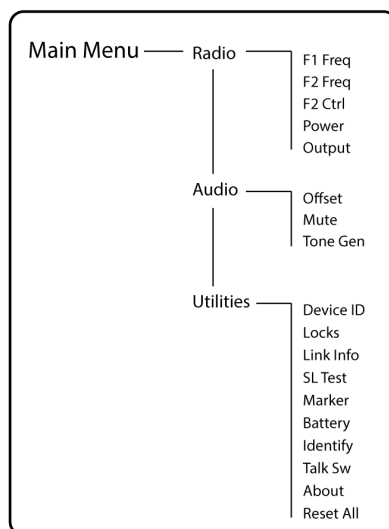

Menu Parameter Descriptions

Radio Menu

F1 Freq

Press the enter button to enable editing of a group (G:) channel (C:) or frequency (MHz). Use the arrow buttons to adjust the values. To edit the frequency, press the O button once to edit the first 3 digits, or twice to edit the second 3 digits.

F2 Freq

Press the enter button to enable editing of a group (G:) channel (C:) or frequency (MHz). Use the arrow buttons to adjust the values. To edit the frequency, press the O button once to edit the first 3 digits, or twice to edit the second 3 digits.

F2 Ctrl

Turns F2 (F2 Freq) On or Off.

Power

Higher power settings can extend the range of the transmitter.

Note: Higher RF power settings decrease battery runtime.

Output

- On: RF signal is active
- Mute: RF signal is inactive

Audio Menu

Offset

Adjust Offset level to balance mic levels when using two transmitters or when assigning multiple transmitters to receiver slots. Adjustment range: -12 dB to +21 dB.

Mute

When enabled, the power switch is configured as a mute switch for the audio:

- Power switch on: audio signal on
- Power switch off: audio signal muted

Tone Gen

Transmitter will generate a continuous test tone:

- Freq: The tone can be set to 400 Hz or 1000 Hz.
- Level: Allows for adjustment of the output level of the test tone.

Utilities Menu

Device ID

Assign a device ID of up to 9 letters or numbers.

Locks

Locks the transmitter controls and power switch.

- None: The controls are unlocked
- Power: The power switch is locked
- Menu: The menu parameters are locked
- All: The power switch and menu parameters are locked

Link Info

Displays the following information about the link between a transmitter and receiver:

- Not Linked: The transmitter is not linked to a receiver
- Linked: The transmitter is linked to a receiver. Select Unlink? to free the transmitter from the receiver link.
- Unlinked: The transmitter is not linked to a receiver

SL Test

ShowLink test tool to measure the boundaries of ShowLink coverage.

Marker

When enabled, press the enter button to drop a marker in Wireless Workbench.

Battery

Displays battery information:

- Battery Life: Runtime reported in bar display and time (hours:minutes)
- Charge: Percentage of charge capacity
- Health: Percentage of current battery health
- Cycle Count: Total of the number of charging cycles for the installed battery
- Temperature: Battery temperature reported in Celsius and Fahrenheit

Talk Sw

Press ENTER to add control from a talk switch. Press the button on the talk switch twice to complete the link.

Identify

When enabled, Identify flashes the transmitter icon in Wireless Workbench Inventory or Monitor tabs.

About

Displays the following transmitter information:

- Model: Displays the model number
- Band: Displays the tuning band of the transmitter
- FW Version: Installed firmware
- HW Version: Hardware version
- Serial Num: Serial number

Reset All

Restores all transmitter parameters to factory settings.

IR Sync

Use IR Sync to form an audio channel between the transmitter and receiver.

Note: The receiver band must match the band of the transmitter.

1. Select a receiver channel.
2. Tune the channel to an available frequency using group scan or manually turn to an open frequency.
3. Power on the transmitter.

4. Press the SYNC button on the receiver.
5. Align the IR windows between the transmitter and the receiver so that the IR LED illuminates red. When complete, Sync Success! appears. The transmitter and receiver are now tuned to the same frequency.

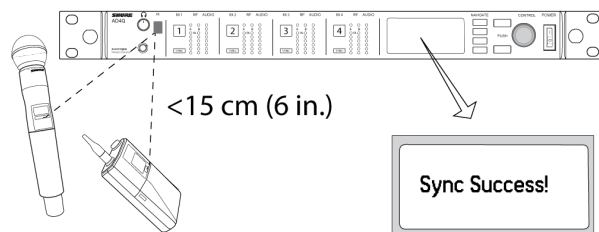

Note:

Any change to the encryption status on the receiver (enabling/disabling encryption) requires a sync to send the settings to the transmitter. New encryption keys for the transmitter and receiver channel are generated on every IR sync, so to request a new key for a transmitter, perform an IR sync with the desired receiver channel.

Setting the Frequency Manually

The transmitter can be manually tuned to a specific frequency, group, or channel.

1. Navigate to the Radio menu and select F1 Freq or F2 Freq.
2. Scroll to select G: and C: to edit the group and channel, or select the frequency parameter (MHz). When editing the frequency, press O one to enable editing of the first three digits, or twice to edit the last three digits.
3. Use the \wedge \vee buttons to adjust the group, channel, or frequency.
4. Press O to save, and then press X when finished.

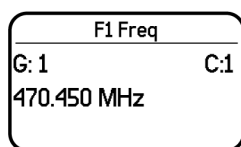

RF Mute

RF Mute prevents transmission of the audio by suppressing the RF signal, while allowing the transmitter to remain powered-on. The home screen displays RF MUTED in this mode.

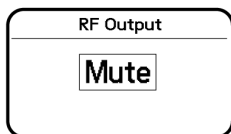

1. From the Radio menu, navigate to Output.
2. Choose one of the following options:
 - On: RF signal is active
 - Mute: RF signal is disabled
3. Press O to save.

Turning the transmitter off and on, or replacing the battery will restore Output to On.

Safe Start

Power on in Safe Start mode to prevent interference with other devices. Hold the X button while powering on your device until the Safe Start menu appears.

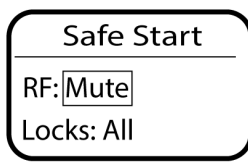

Safe Start menu options:

- RF: Mute or On
- Locks: None, Pwr, Menu, All

Use the navigation buttons to make changes.

To exit the Safe Start menu, cycle the power or momentarily remove the battery.

Previous settings for locks and RF will be retained when the transmitter is powered on in Safe Start.

Operating in Frequency Diversity Mode

Operating the AXDFD2 in frequency diversity mode with an Axient Digital receiver enables simultaneous transmission of audio on 2 independent frequencies.

1. Select a channel and navigate to the Frequency Diversity setting: Advanced > Frequency Diversity .
2. Use the control wheel to select the Combining option.
3. Press ENTER to confirm and save.
4. Perform an IR sync to link the transmitter to the receiver.

In Frequency Diversity, the transmitter will operate on two adjacent receiver channels (1 and 2 or 3 and 4).

Turning Off Frequency 2 (Freq 2)

If a problem develops with one of the frequencies being used by the transmitter, you can lock on to a single frequency by turning off frequency 2. Turning off one frequency allows the transmitter to continue passing audio while a clear frequency can be found for the second channel.

1. From the Radio menu navigate to F2 Ctrl.
2. Use the controls to set F2 to On or Off. When set to On, the transmitter will pass audio using Freq 2.

Input Overload

The OVERLOAD message appears when the audio input experiences a high-level signal. The power LED turns red as an additional indicator of an overload. Reduce the input signal or enable the input pad to remove the overload condition.

Tip: To enable the input pad, navigate to Audio > Pad and select -12 dB.

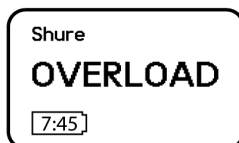

Tone Generator

The transmitter contains an internal tone generator that produces a continuous audio signal. The tone is helpful when conducting a sound check or for troubleshooting the audio signal chain. The level of the tone is adjustable from -60 dB to 0 dB and the frequency can be set to 400 Hz or 1000 Hz.

Always start with the level set to -60 dB to avoid overloading speakers or headphones.

1. From the Audio menu select Tone Gen.
2. Set the frequency to 400 Hz or 1000 Hz.
3. Select Level and use the arrow buttons adjust the value between -60 dB and 0 dB.

Turn off the tone by selecting Off from the menu or by cycling the transmitter power.

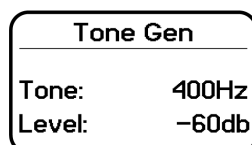

Matching Audio Levels with Mic Offset

When linking two or more transmitters to a receiver, there may be a difference in volume levels between microphones or instruments. If this occurs, use the Offset function to match the audio levels and eliminate audible volume differences between transmitters. If using a single transmitter, set Offset to 0 dB.

1. Turn on the first transmitter and perform a sound check to test the audio level. Turn off the transmitter when finished.
2. Turn on the second transmitter and perform a sound check to test the audio level. Repeat for any additional transmitters.
3. If there is an audible difference in the sound level between the transmitters, navigate to the Offset menu (Audio > Offset) in the transmitter to increase or decrease the Offset in realtime to match the audio levels.

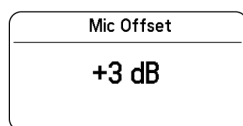

ShowLink Test

The ShowLink Test is a tool to find the boundaries of the ShowLink coverage area. When the ShowLink test is activated, a five-bar display indicating the link quality is shown on the screen. As the transmitter moves away from the access point, the number of bars will decrease. ShowLink control is maintained as long as 1 bar is displayed.

If the transmitter is beyond the coverage range, ShowLink control will not be possible. However, the audio signal will not be affected or interrupted as long as the transmitter is within range of the RF signal.

To improve coverage, adjust the location of your access points or place additional access points to extend coverage.

To activate the ShowLink Test:

1. From the Utilities menu, navigate to SL Test.
2. Press the O button to start the test and walk the transmitter around the coverage area. Monitor the number of bars displayed and the state of the ShowLink icon. Coverage boundaries are indicated by 0 bars displayed or the ShowLink icon is empty.
3. Press the X button to exit the ShowLink test.

Tip: During a ShowLink test, press O (enter) to drop a marker in Wireless Workbench.

Updating Firmware

Firmware is embedded software in each component that controls functionality. Periodically, new versions of firmware are developed to incorporate additional features and enhancements. To take advantage of design improvements, you can upload and install new versions of the firmware by using the Shure Update Utility. The Shure Update Utility is available for download from <http://www.shure.com/>.

Firmware Versioning

When performing an update, first download firmware to the receiver, and then update transmitters to the same firmware version to ensure consistent operation.

The firmware numbering for Shure devices uses the following format: MAJOR.MINOR.PATCH (e.g., 1.2.14). At a minimum, all devices on the network (including transmitters), must have the same MAJOR and MINOR firmware version numbers (e.g., 1.2.x).

Updating the Transmitter

1. Download the firmware to the receiver.
2. Access the following menu from the receiver: Device Configuration > Tx Firmware Update.
3. Align the IR ports between the transmitter and the receiver. IR ports must be aligned for the entire download, which can take 50 seconds or longer.

The red alignment LED will turn on when the alignment is correct.

4. Press ENTER on the receiver to begin the download to the transmitter. The receiver will display the progress of the update as a percentage.

Specifications

Mic Offset Range

-12 to 21 dB (In 1 dB steps)

Battery Type

Shure SB920 Rechargeable Li-Ion

Battery Runtime

Shure SB920 @ 10 mW

Single Carrier Mode	Up to 9 hours
Frequency Diversity	Up to 6.5 hours

Dimensions

254 mm x 51 mm (10.0 in. x 2.0 in.) L x Dia.

Weight

338 g (11.9 oz.), Without Battery

Housing

Cast Aluminum

Operating Temperature Range

-18°C (0°F) to 45°C (113°F)

Storage Temperature Range

-29°C (-20°F) to 74°C (165°F)

Audio Input

Configuration

Unbalanced

Maximum Input Level*1 kHz at 1% THD*

145 dB SPL (SM58), typical

RF Output**Antenna Type**

Integrated Dual Band Helical

Occupied Bandwidth

<200 kHz

Channel-to-Channel Spacing

Standard Mode	350 kHz
High Density Mode	125 kHz

Modulation Type

Shure Axient Digital Proprietary

Power*See Frequency Range and Output Power table, varies by region*

Single Carrier Mode	2 mW, 10 mW, 50 mW
Frequency Diversity	2x20 mW

Specific Absorption Rate (SAR)

< 0.21 W/kg

ShowLink**Network Type**

IEEE 802.15.4

Antenna Type

Zigbee Dual Conformal

Frequency Range

2.40 to 2.4835 GHz (24 Channels)

RF Output Power

10 dBm (ERP)



Frequency Range and Transmitter Output Power

Band	Frequency Range (MHz)	Power Single Carrier (mW) ^{***}	Power Frequency Diversity (mW Per Channel) ^{***}
G53	470 to 510	2/10/50	2/10/20
G54	479 to 565	2/10/20	2/10/20
G55†	470 to 636	2/10/50	2/10/20
G56◇	470 to 636	2/10/50	2/10/20
G57	470 to 608	2/10/50	2/10/20
G62	510 to 530	2/10/50	2/10/20
H54	520 to 636	2/10/50	2/10/20
K53	606 to 698	2/10/50	2/10/20
K55	606 to 694	2/10/50	2/10/20
K56	606 to 714	2/10/50	2/10/20
K57	606 to 790	2/10/50	2/10/20
K58	622 to 698	2/10/50	2/10/20
L54	630 to 787	2/10/50	2/10/20
L60	630.125 to 697.875	2/10/50	2/10/20
P55	694 to 703, 748 to 758, 803 to 806	2/10/50	2/10/20/50
R52	794 to 806	10	10
X55	941 to 960	2/10/50	2/10/10

^{***}Power delivered to the antenna port.

†Operation mode varies according to region. In Brazil, High Density mode is used. The maximum power level for Peru is 10mW.

◇Korea defines power as conducted (ERP) which is 1dB less than declared in table.

เครื่องโทรคมนาคมและอุปกรณ์นี้มีความสอดคล้องตามมาตรฐานหรือข้อกำหนดทางเทคนิคของ กสทช.

K55 606-694 MHz

Country Code	Frequency Range
Code de Pays	Gamme de frequences
Codice di paese	Gamme di frequenza
Código de país	Gama de frecuencias
Länder-Kürzel	Frequenzbereich
A, B, BG, CH, CY, CZ, D, DK, EST, F	*
FIN, GB, GR, H, HR, I, IRL, IS, L, LT	*
M, N, NL, P, PL, RO, S, SK, SLO, TR	*
all other countries	*

* This equipment may be capable of operating on some frequencies not authorized in your region. See [Licensing Information](#).

G56 470-636 MHz

Country Code	Frequency Range
Code de Pays	Gamme de frequences
Codice di paese	Gamme di frequenza
Código de país	Gama de frecuencias
Länder-Kürzel	Frequenzbereich
A, B, BG, CH, CY, CZ, D, DK, EST, F	*
FIN, GB, GR, H, HR, I, IRL, IS, L, LT	*
M, N, NL, P, PL, RO, S, SK, SLO, TR	*
all other countries	*

* This equipment may be capable of operating on some frequencies not authorized in your region. See [Licensing Information](#).

K57 606-790 MHz

Country Code	Frequency Range
Code de Pays	Gamme de frequences
Codice di paese	Gamme di frequenza
Código de país	Gama de frecuencias
Länder-Kürzel	Frequenzbereich
A, B, BG, CH, CY, CZ, D, DK, EST, F	*
FIN, GB, GR, H, HR, I, IRL, IS, L, LT	*
M, N, NL, P, PL, RO, S, SK, SLO, TR	*
all other countries	*

* This equipment may be capable of operating on some frequencies not authorized in your region. See [Licensing Information](#).

Please follow your regional recycling scheme for batteries, packaging, and electronic waste.

No user-operated control of power, frequency, or other parameters are available beyond those specified in this operating manual.

Australia Warning for Wireless

This device operates under an ACMA class licence and must comply with all the conditions of that licence including operating frequencies. Before 31 December 2014, this device will comply if it is operated in the 520-820 MHz frequency band.

WARNING: After 31 December 2014, in order to comply, this device must not be operated in the 694-820 MHz band.

低功率電波輻射性電機管理辦法

第十二條

經型式認證合格之低功率射頻電機，非經許可，公司、商號或使用者均不得擅自變更頻率、加大功率或變更原設計之特性及功能。第十四條

低功率射頻電機之使用不得影響飛航安全及干擾合法通信；經發現有干擾現象時，應立即停用，並改善至無干擾時方得繼續使用。前項合法通信，指依電信法規定作業之無線電通信。低功率射頻電機須忍受合法通信或工業、科學及醫療用電波輻射性電機設備之干擾。

LICENSING INFORMATION

Licensing: A ministerial license to operate this equipment may be required in certain areas. Consult your national authority for possible requirements. Changes or modifications not expressly approved by Shure Incorporated could void your authority to operate the equipment. Licensing of Shure wireless microphone equipment is the user's responsibility, and licensability depends on the user's classification and application, and on the selected frequency. Shure strongly urges the user to contact the appropriate telecommunications authority concerning proper licensing, and before choosing and ordering frequencies.

Certifications

Certified under FCC Part 15 and FCC Part 74.

Certified by ISED in Canada under RSS-210.

FCC ID: DD4ADX2FDG57, DD4ADX2FDK54, DD4ADX2FDX55. **IC:** 616A-ADX2FDG57, 616A-ADX2FDK54.

Meets essential requirements of the following European Directives:

- WEEE Directive 2012/19/EU, as amended by 2008/34/EC
- RoHS Directive EU 2015/863

Note: Please follow your regional recycling scheme for batteries and electronic waste

This product meets the Essential Requirements of all relevant European directives and is eligible for CE marking.

Hereby, Shure Incorporated declares that the radio equipment is in compliance with Directive 2014/53/EU. The full text of the EU declaration of conformity is available at the following internet address: <http://www.shure.com/europe/compliance>

Authorized European representative:

Shure Europe GmbH

Headquarters Europe, Middle East & Africa

Department: EMEA Approval

Jakob-Dieffenbacher-Str. 12

75031 Eppingen, Germany

Phone: +49-7262-92 49 0

Fax: +49-7262-92 49 11 4

Email: EMEAsupport@shure.de

Information to the user

This device complies with part 15 of the FCC Rules. Operation is subject to the following two conditions:

1. This device may not cause harmful interference.
2. This device must accept any interference received, including interference that may cause undesired operation.

Note: This equipment has been tested and found to comply with the limits for a Class B digital device, pursuant to part 15 of the FCC Rules. These limits are designed to provide reasonable protection against harmful interference in a residential installation. This equipment generates uses and can radiate radio frequency energy and, if not installed and used in accordance with the instructions, may cause harmful interference to radio communications. However, there is no guarantee that interference will not occur in a particular installation. If this equipment does cause harmful interference to radio or television reception, which can be determined by turning the equipment off and on, the user is encouraged to try to correct the interference by one or more of the following measures:

- Reorient or relocate the receiving antenna.
- Increase the separation between the equipment and the receiver.
- Connect the equipment to an outlet on a circuit different from that to which the receiver is connected.
- Consult the dealer or an experienced radio/TV technician for help.

This device operates on frequencies shared with other devices. Consult the Federal Communications Commission White Space Database Administration website to determine available channels in your area prior to operation.

Canada Warning for Wireless

This device operates on a no-protection, no-interference basis. Should the user seek to obtain protection from other radio services operating in the same TV bands, a radio licence is required. For further details, consult Innovation, Science and Econom-

ic Development Canada's document Client Procedures Circular CPC-2-1-28, Voluntary Licensing of Licence-Exempt Low-Power Radio Apparatus in the TV Bands.

Ce dispositif fonctionne selon un régime de non_brouillage et de non_protection. Si l'utilisateur devait chercher à obtenir une certaine protection contre d'autres services radio fonctionnant dans les mêmes bandes de télévision, une licence radio serait requise. Pour en savoir plus, veuillez consulter la Circulaire des procédures concernant les clients CPC_2.1.28, Délivrance de licences sur une base volontaire pour les appareils radio de faible puissance exempts de licence et exploités dans les bandes de télévision d'Innovation, Sciences et Développement économique Canada.

This device contains licence-exempt transmitter(s)/receiver(s) that comply with Innovation, Science and Economic Development Canada's licence-exempt RSS(s). Operation is subject to the following two conditions:

1. This device may not cause interference.
2. This device must accept any interference, including interference that may cause undesired operation of the device.

L'émetteur/récepteur exempt de licence contenu dans le présent appareil est conforme aux CNR d'Innovation, Sciences et Développement économique Canada applicables aux appareils radio exempts de licence. L'exploitation est autorisée aux deux conditions suivantes :

1. L'appareil ne doit pas produire de brouillage;
2. L'appareil doit accepter tout brouillage radioélectrique subi, même si le brouillage est susceptible d'en compromettre le fonctionnement.

Contact Customer Support

Didn't find what you need? [Contact our customer support](#) to get help.